

Model Table

Model	Output ●	Output ●●○	Recommended controller
OPT-LIU205	24V/9.6W	24V/9.6W	OPT-DPA1024E
OPT-LIU285	24V/57.6W	24V/115.2W	OPT-DPA6024
OPT-LIU362	24V/57.6W	24V/96.0W	OPT-DPA6024
OPT-LIU423	24V/96.0W	24V/168.0W	OPT-DPA6024
OPT-LIU500	24V/76.8W	24V/115.2W	OPT-DPA6024
OPT-LIU600	24V/76.8W	24V/134.4W	OPT-DPA6024
OPT-LIU822	24V/168.0W	24V/235.2W	OPT-DPA6024
OPT-LIU960	24V/172.8W	24V/288.0W	OPT-DPA6024

Dimensional Drawings [mm]

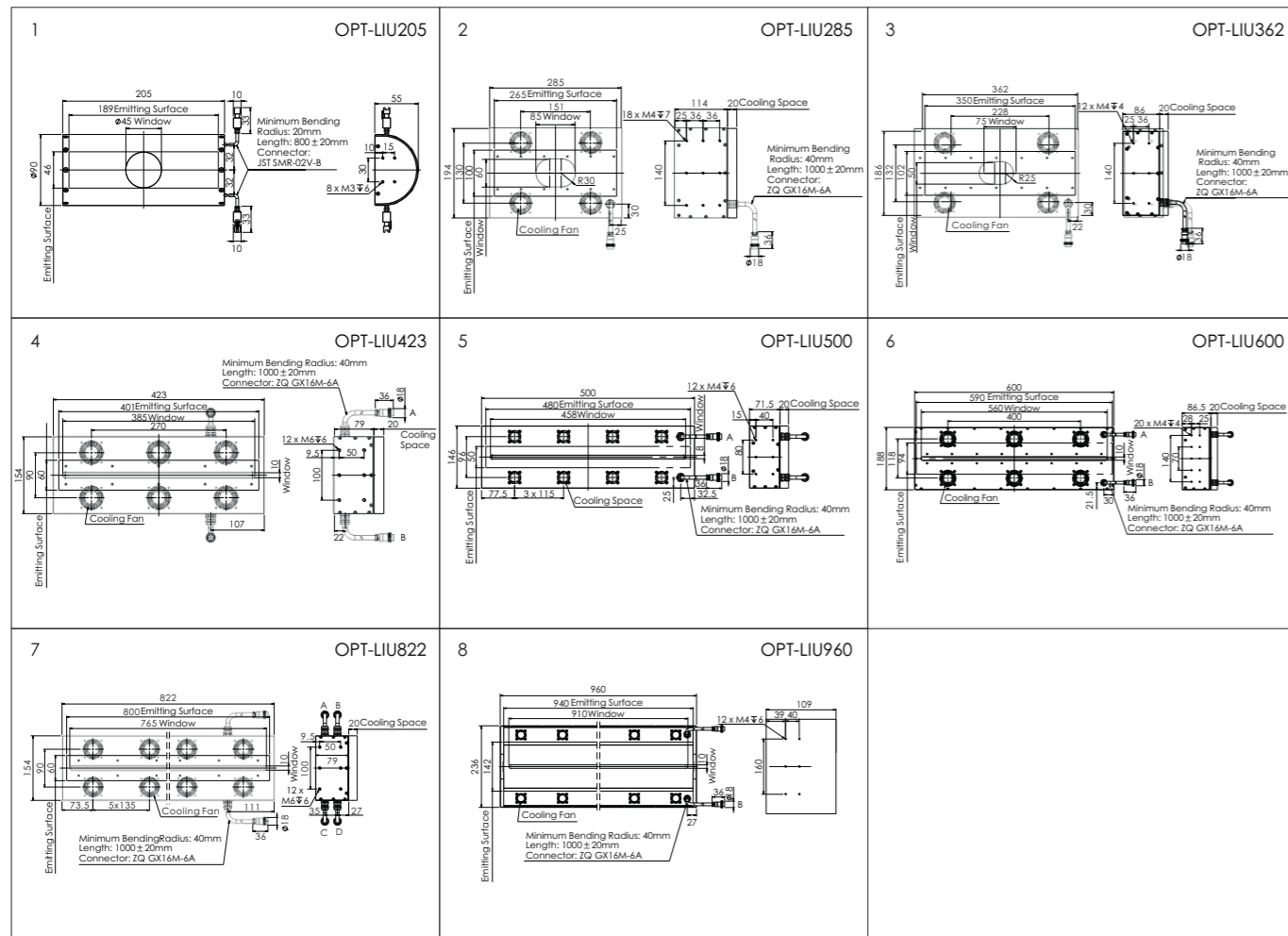

Waterproof Lights Used in many dusty and wet environments, compliant with IP67 rating



Product Features

- 1 OPT standard items are also available as waterproof variants
- 2 Compliant with IP67 rating
- 3 Ideal for hassle-free operation in dusty and wet environments

OPT waterproof light are thoroughly tested. They are not just allied in dusty and wet environments, but also for outdoor or under-water applications. Their very compact design, few gaps in the housing and high-end sealing ensure the tightness. OPT waterproof lights also feature a heat transfer system to extend the lifetime of the LEDs.

Customization Options

- Color
- Size
- Installation method
- Waterproof standard
- Heat release method
- Independent control of different areas

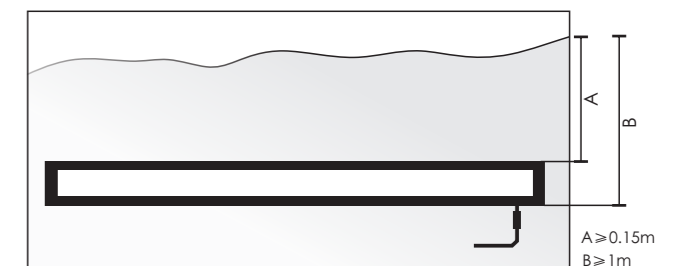

The light is tested for 2 hours in a water depth between 15 cm and 1 m.

Application Example



Screw thread inspection



Bottle mouth inspection

Model Table

Model	Output ●	Output ●●○	Recommended controller
OPT-FL12692-IP67	24V/4.1W	24V/6.1W	OPT-DPA1024E
OPT-LI22034-IP67	24V/2.4W	24V/4.8W	OPT-DPA1024E
OPT-RI10030-IP67	24V/4.6W	24V/5.7W	OPT-DPA1024E

Dimensional Drawings [mm]

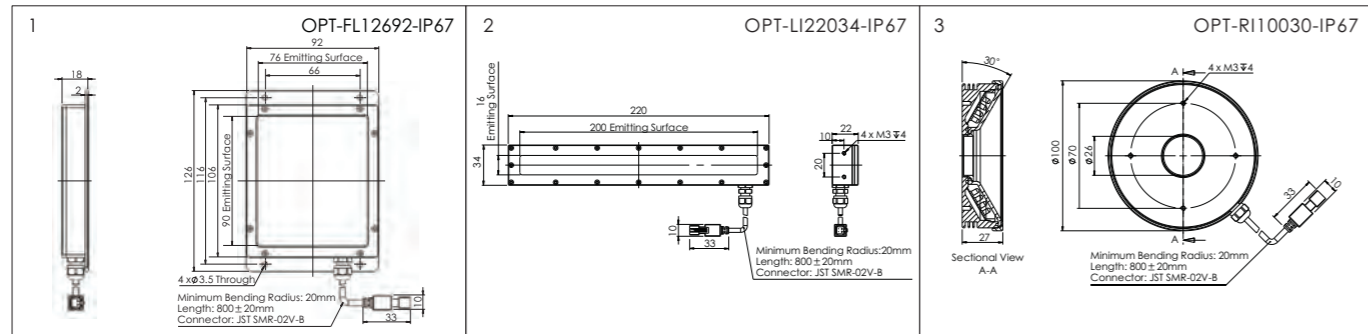

Customized Air Cooled Lights

New Product

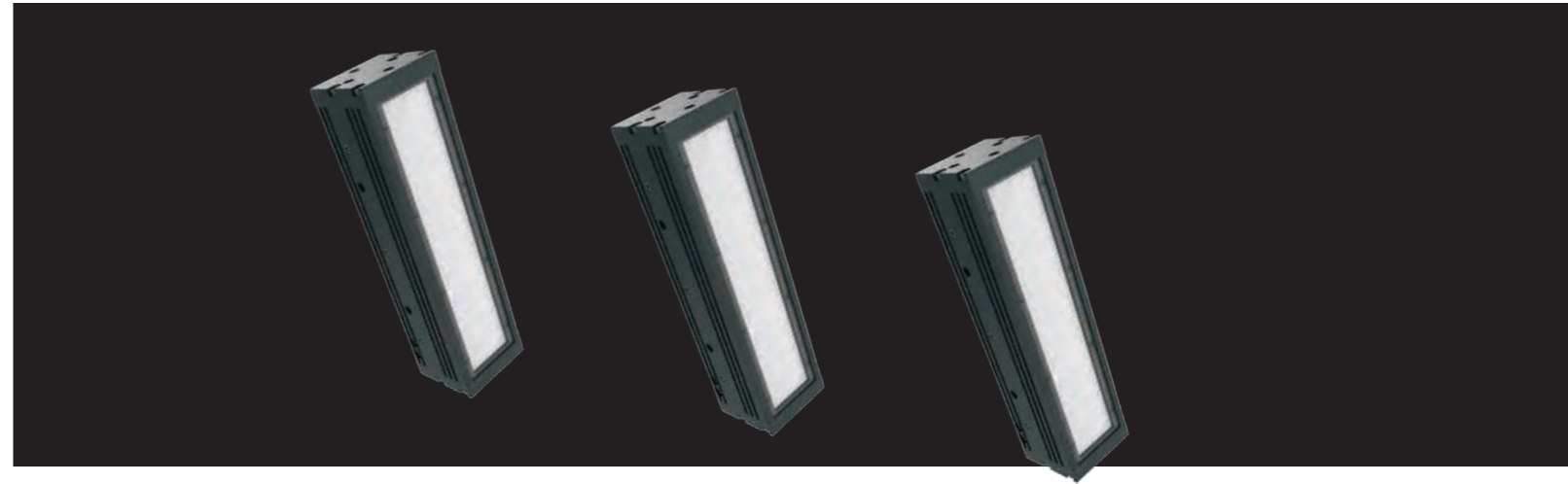

Product Features

- 1 Compact footprint
- 2 Reduced speckles thanks to a special lens design
- 3 Suitable for dust-free environments; requires air compressor

Customization Options

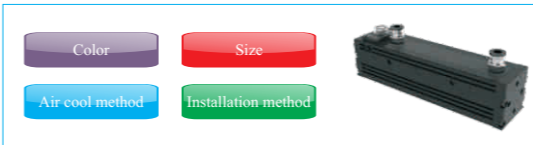

Model Table

Model	Output ●●○	Color	Size	Recommended controller
OPT-LSG197	24V/84W	●●●	1	DPA6024

Dimensional Drawings [mm]

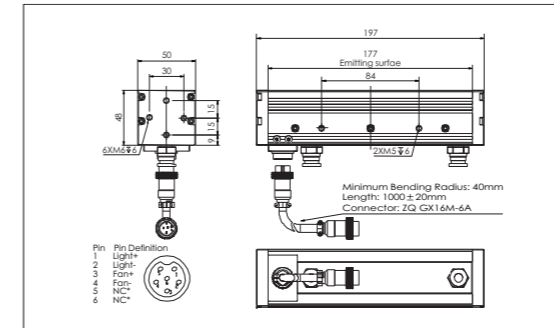

Application Example



Application Areas

- ◆ Mobile screen surface defects inspection
- ◆ Aluminum surface inspection for scratches
- ◆ Steel surface defects inspection

Selection Guide

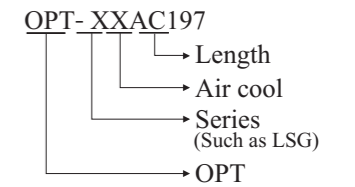

Uniformity Chart

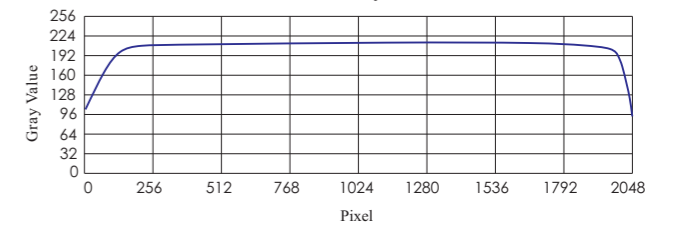

Cross-sectional Drawing

